

Two-handed HD GREASE GUN CASSIDA and CASSIDA Grease Portfolio



MOVING YOUR WORLD



FUCHS LUBRICANTS GERMANY

We don't just develop lubricants. For highly complex challenges in a wide range of industries, we develop innovative lubricant solutions that enable the mobility of tomorrow. Our goal: to keep our customers' world in motion. Efficient, sustainable, reliable. Today and tomorrow.

What can we move for you?

FUCHS LUBRICANTS GERMANY

Facts and figures

Company: FUCHS LUBRICANTS GERMANY GmbH, a company of the FUCHS Group

Locations: Mannheim, Dohna, Kaiserslautern, Kiel and Wedel; approx. 1,400 employees

Product range: A full range of more than 3,000 products for all application areas

Certifications i. a.: ISO 9001, IATF 16949, ISO 14001, ISO 45001, ISO 50001, ISO 21469, HALAL, KOSHER (detailed certifications at www.fuchs.com/de/en)

Gate-to-Gate CO₂-compensated**

FUCHS LUBRICANTS GERMANY is a subsidiary of FUCHS SE, the world's largest independent supplier of lubricant solutions. Around 1,400 specialists at the headquarters in Mannheim and the sites in Kaiserslautern, Wedel, Kiel and Dohna work with dedication on innovative lubricant solutions that enable the mobility of tomorrow.

The high level of technical consulting expertise combined with the largest, nationwide network of its own technical contacts makes FUCHS LUBRICANTS GERMANY a reliable local partner. A comprehensive product range, supplemented by digital offerings and Smart Services, as well as many years of lubricant expertise and a high level of research competence are the foundations for the innovative FUCHS lubricant solutions. They reduce wear and energy requirements, extend the running times and service life of machines, and thus keep the world moving - from industrial motors and e-cars to wind turbines and washing machines. FUCHS LUBRICANTS GERMANY is certified according to a wide range of standards and, as a technology leader and development partner, places the highest demands on quality management.

Customers in all industries benefit from this quality management: automotive suppliers and OEM, mechanical engineering, metal processing, mining and exploration, aerospace, energy, construction and transport, agriculture and forestry, as well as the paper, steel, metal, cement, forging and food industries, but also qualified lubricant dealers, car dealerships and workshops.

MOVING YOUR WORLD

*Gate-to-Gate Scope includes GHG-Protocol Scope 1, 2 and selected Scope 3 emissions (water, waste, business travel, commuting)

The HD GREASE GUN CASSIDA for all CASSIDA greases



The extensive range of CASSIDA high-performance food grade lubricants is supplemented by the two-handed CASSIDA GREASE GUN and forms the perfect combination for efficiently lubricating your application.

The two-handed gun guarantees clean and safe lubrication of your machines, even through long lubrication pipes, large quantities of lubricants and large volumes of lubricant per stroke. Particularly simple handling is achieved with the use of a matching SR-cartridge with screw cap.

Your Benefits:

Makes maintenance simple

It produces 400 bar/5800 psi of pressure for improved and easier lubrication.

Utilises unique screw fit cartridges

These SR-cartridges can be removed, resealed and exchanged simply, efficiently and cleanly to reduce grease wastage.

Works by using a special vacuum principle

This ensures that each SR-cartridge is emptied completely, regardless of whether it is removed from the gun on numerous occasions.

Most efficient CASSIDA SR-Grease System

The system is designed for long and reliable service. There are no moving parts or an outer casing that can be damaged.

Is easy to handle

The grease gun has ergonomic grips and symmetrical handles for easy operation. The gun is additionally equipped with a practical hose parking unit which reduces possible contamination of the nozzle while not in use.

TWIN-LOCK guide and sealing rings

The TWIN-LOCK system avoids a pseudo supply of the point of lubrication by preventing grease from escaping at the piston and a backflow into the cartridge.

Uses a dual-handle design

The system's solid, simple design makes application easier for the operator and requires less manual force to pump the grease than traditional guns.

Minimized likelihood of confusion

The cartridge is in full view, ensuring that the type of grease, the recommended applications and the colour coding are always visible.

Offers a complete, cost-effective grease system

There is no need for multiple guns and an armoured hose with a grip coupling is provided.

Available with SR-cartridges

Compared to standard cartridges and grease guns, the SR-Grease System contains a higher grease volume at a lower total weight.

Offers highest food safety

The gun is pre-lubricated with food grade grease, which ensures the highest level of food safety.

You want to know more about this grease gun? Here you can see how it works:



How to use the HD GREASE GUN CASSIDA

The System Components:

Armoured hose with grip coupling



TWIN-LOCK system

Ergonomic grips

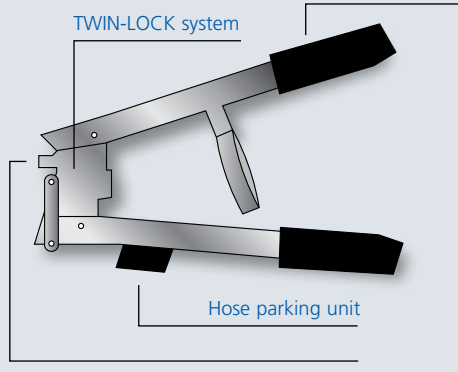

Hose parking unit

Pre-lubricated with food grade lubricant

SR cartridge

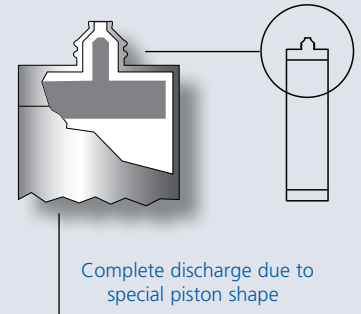

Complete discharge due to special piston shape

Handling

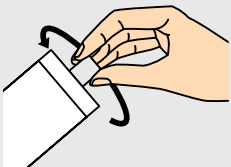

Twist off the screw cap from the cartridge.

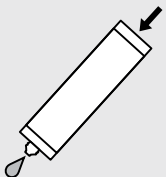

Due to the filling process a small quantity of air may be trapped in the area of the screw thread. Gently press the centre of the piston to push out this air in order to ensure that the lubricant reaches the pump unit sooner.

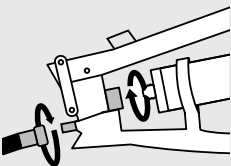

Attach the hose to the gun head. This design allows a maximum pressure of 400 bar and a lubricant quantity per stroke of approximately 1.5cm³.

Screw in the cartridge up to the stop line. Operate the grease gun until lubricant appears at the end of the hose (3–5 strokes).

Now the grease gun is ready to use.

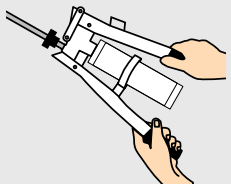

The grease gun should be opened smoothly and completely at each stroke. Depending on the temperature and type of lubricant grease, a short waiting time is recommended.

As soon as you feel a resistance when closing the grease gun its use can be continued.

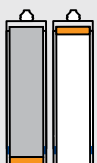

You can check the lubricant level in the cartridge at any time (left: filled cartridge, right: completely empty cartridge).

General Instructions for use

- **Before starting lubrication:**
Ensure that the grease nipple and the grip coupling are clean.
- **During lubrication:**
The coupling must sit straight on the grease nipple. If you hold the coupling at an angle, the grease nipple will not be fully covered. Check the lubrication process/grease outlet.
- **After lubrication:**
Do not pull the coupling straight off the grease nipple, but bend it sideways. Defective/sticky grease nipples must be replaced as soon as possible.



Unpacking and initial operation:



The CASSIDA grease portfolio

Never underestimate the importance of the right lubricating grease! Greases are an integral part of achieving optimum performance of your machinery. CASSIDA greases cover a wide variety of applications and specifications to ensure that things run smoothly. The CASSIDA SR-Grease System is available throughout the entire CASSIDA grease portfolio.



CASSIDA GREASE RLS 1 and 2
Multi-purpose greases for regularly loaded bearings – good adhesive properties and water resistance.



CASSIDA GREASE HTS 2
High-performance grease for plain and roller bearings operating at temperatures up to 200°C (peak 220°C).



CASSIDA GREASE EPS 1 and 2
Outstanding protection against wear and rust. Multi-purpose grease suitable for bearings used under extreme conditions and at high speeds.



CASSIDA GREASE FC 1 and 2
PFPE greases for use in continuous high temperatures and/or in aggressive environments.



CASSIDA GREASE GTX 2
Specialty grease for heavily loaded or slow moving bearings with excellent water resistance and outstanding protection against wear and rust.



CASSIDA GREASE LTS 1
Specialty low-temperature grease for roller bearings. Operating temperature down to -50°C.



CASSIDA GREASE GTS 2
Multi-purpose grease suitable for bearings used under extreme conditions and at high speeds with outstanding protection against wear and rust.



CASSIDA FM GREASE DC 2
Specialty direct contact, multifunctional grease for food processing applications in the food manufacturing industry.



CASSIDA FM GREASE EP 1.5
Specialty semi-synthetic extreme pressure grease for food and beverage processing equipment.



CASSIDA GREASE MD 2
Silicone grease for the lubrication of all sorts of taps, flow meters and fittings with EPDM seals, used for the handling of water, drinks and beer, including drum-filling inflow valves – provides high resistance against chemicals.



CASSIDA GREASE HDS 2
Heavy-duty grease providing excellent protection for heavily loaded or slow moving bearings. Outstanding tackiness and excellent water resistance.



















CASSIDA GREASE CLEAR 2
Synthetic specialty grease for food and beverage processing equipment.



CASSIDA FM GREASE HD 2
Specialty heavy-duty grease for food and beverage processing equipment.

Product overview

Product	Base oil	Thickener	Base oil viscosity [mm ² /s]		NLGI grade	Temperature range	Colour code
			@ 40°C	@ 100°C			
Regular load							
CASSIDA GREASE RLS 1	Synthetic	AlCx	150	18	1	-40 to 120°C (peak 140°C)	
CASSIDA GREASE RLS 2	Synthetic	AlCx	150	18	2	-35 to 120°C (peak 140°C)	
Extreme pressure							
CASSIDA GREASE EPS 1	Synthetic	AlCx	220	25	1	-40 to 120°C (peak 140°C)	
CASSIDA GREASE EPS 2	Synthetic	AlCx	220	25	2	-35 to 120°C (peak 140°C)	
CASSIDA GREASE GTX 2	Synthetic	CsCx	460	44	2	-35 to 180°C (peak 220°C)	
CASSIDA GREASE GTS 2	Synthetic	CsCx	85	12.8	2	-45 to 170°C (peak 200°C)	
CASSIDA FM GREASE EP 1.5	White Oil	mod. AlCx	220	22	1.5	-30 to 140°C (peak 150°C)	
Heavy duty							
CASSIDA GREASE HDS 2	Synthetic	AlCx	800	67	2	-30 to 120°C (peak 140°C)	
CASSIDA FM GREASE HD 2	White Oil	mod. AlCx	550	37.8	2	-10 to 140°C (peak 150°C)	
High temperature							
CASSIDA GREASE HTS 2	Synthetic	Inorganic	400	40	2	-30 to 200°C (peak 220°C)	
CASSIDA GREASE FC 1	Synthetic	PTFE	510	47	1	-25 to 260°C (peak 280°C)	
CASSIDA GREASE FC 2	Synthetic	PTFE	510	47	2	-25 to 260°C (peak 280°C)	
Low temperature							
CASSIDA GREASE LTS 1	Synthetic	AlCx	20	4.8	1	-50 to 100°C (peak 110°C)	
Direct contact (3H)							
CASSIDA FM GREASE DC 2	White Oil	Inorganic	100	11	2	-10 to 110°C (peak 120°C)	
Special purpose							
CASSIDA GREASE MD 2	Synthetic	PTFE	650	250	2	-40 to 200°C (peak 250°C)	
CASSIDA GREASE CLEAR 2	Synthetic	Inorganic	75	11.5	2	-30 to 170°C	

All CASSIDA grease cartridges are colour coded for ease of identification.

Note

The information contained in this brochure is based on the experience and expertise of FUCHS LUBRICANTS GERMANY GmbH in the development and manufacture of lubricants and represents the current state of the art. The performance of our products can be influenced by a series of factors, especially the specific use, the method of application, the operational environment, component pretreatment, possible external contamination, etc. For this reason, it is not possible to make universally valid statements about the function of our products.

Our products may not be used in aircraft or spacecraft. Our products may be used for producing aircraft and spacecraft components if the products are completely removed from the components before they are fitted in the aircraft or spacecraft.

The information given in this product information represents general, non-binding guidelines. No warranty expressed or implied is given concerning the properties of the product or its suitability for any given application. We therefore recommend that you consult a FUCHS LUBRICANTS GERMANY GmbH application engineer to discuss application conditions and the performance criteria of the products before the products are used. It is the responsibility of the user to test the functional suitability of the products and to use them with the corresponding care. Our products are subject to continuous further development. We therefore retain the right to change our product range, the products, and their manufacturing processes as well as all details in this brochure at any time and without warning, provided that no customer-specific agreements exist that require otherwise. With publication of this product information leaflet, all previous editions cease to be valid. Any form of reproduction requires express prior written permission from FUCHS LUBRICANTS GERMANY GmbH.

Innovative lubricants need experienced application engineers

Every lubricant change should be preceded by expert consultation on the application in question. Only then can the best lubricant system be selected. Experienced FUCHS engineers will be happy to advise on products for the application in question and also on our full range of lubricants.

Contact:

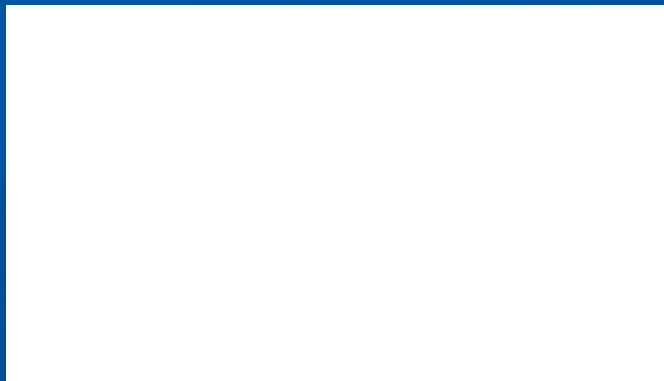

FUCHS LUBRICANTS GERMANY GmbH

Friesenheimer Straße 19
68169 Mannheim/Germany
Phone +49 621 3701-0
Fax +49 621 3701-7000
E-mail zentrale-flg@fuchs.com
www.fuchs.com/de/en

Export Division
Friesenheimer Straße 19
68169 Mannheim/Germany
Phone +49 621 3701-1703
Fax +49 621 3701-7719
E-mail export-flg@fuchs.com
www.fuchs.com/de/en