

Lubrication, Maintenance, Service for Open Gears



LUBRICANTS.
TECHNOLOGY.
PEOPLE.



LUBRITECH
Special Application Lubricants

LUBRICANTS. TECHNOLOGY. PEOPLE.

FUCHS LUBRITECH – Special Application Lubricants

Within the FUCHS Group, we at FUCHS LUBRITECH are the experts for highly specialised applications. We develop, produce and distribute the world's leading branded products of our own. Our employees are committed to solving your challenges. We are there, with you and for you.



LUBRITECH

Special Application Lubricants

Facts and figures

Company: FUCHS LUBRITECH GmbH, part of the FUCHS Group, based in Kaiserslautern, Germany

LUBRITECH: the Special Application Lubricants Division of the FUCHS Group

Product range: LUBRITECH GROUP offers a full range of more than 1,000 special products, including food grade lubricants, adhesive lubricants, lubricating fluids and greases, pastes, solid film lubricants, concrete release agents, aerosols and metal-forming lubricants

Certifications: ISO 9001: 2008, ISO 21469, Halal, Kosher

FUCHS has developed, produced, and sold lubricants and related specialties for more than 80 years – for virtually all applications and sectors. With over 100,000 customers and 50 companies worldwide, the FUCHS Group is the world's leading independent lubricant supplier.

Within the FUCHS Group, **FUCHS LUBRITECH** is the expert for Special Application Lubricants. A team of more than 500 specialists around the world work to meet your needs. However demanding the application, we offer a specialised solution. Service is a crucial and fundamental component of our offering. Our experts offer on-site technical consultation to assure performance, efficiency and process reliability.

FUCHS LUBRITECH special lubricants stand for the highest performance and sustainability, safety and reliability as well as efficiency and cost savings. They represent a promise: **technology that pays back.**

HIGH-PERFORMANCE LUBRICANTS FOR THE MOST DEMANDING APPLICATIONS

Expertise in Open Gear lubricants

With increasing size, the demands on the lubrication of Open Gears also increase. Wherever high transmission of forces at low sliding speeds is required, we do everything we can to reduce the wear on your technology to a minimum, thus maximising the reliability and safety of your equipment. Together with gear and machinery manufacturers, we develop innovative adhesive lubricants for Open Gears in kilns and mills. We always strive for the most application-specific solutions – and thus achieve running times of 40 years and more.



FUCHS LUBRITECH in motion – your reliable partner in Open Gear lubrication

Large Open Gear drives constitute a mechanical method of transmitting movement and force. The level of success ultimately achieved does not only depend on the gear design and materials used but also on the lubricant quality, volume of lubricant and the means of application. This is particularly true for large, low-speed Open Gear drives where high torques are transmitted.



Demands grow with size

The tolerances involved in the manufacture and assembly of girth gear drives increase in proportion to the size of the gear train. Distortions developing under the influence of load and temperature also increase with size. It is not uncommon to see large gears with a diameter of 14 metres. Transmission ratios typically range between 1:8 and 1:12. Under these conditions effective lubrication is often only possible with difficulty because of the slow sliding speed of the working tooth flanks. A special, correctly applied adhesive lubricant will reliably prevent metal-to-metal contact of the tooth flanks. Lubricants with a high proportion of solids and with superior additives ensure safe running properties in the area of boundary friction. As a result a service life exceeding 20 years can be expected.

Open Gear drives do the heaviest work in many branches of industry

Open Gear drives are very common in the raw materials industry. The girth gear drives that are used in tube mills, coolers, washing drums, kilns, calciners and other machines have to transmit enormous torques, i.e. often up to 50,000 Nm. It is only natural that this kind of force subjects the gear wheels to very high stresses. Such gears are usually designed as spur or helical gears with modified involute profiles. The materials used for the gearing are usually CrNiMo tempered steel (pinion) and alloyed CrMo steel casting or cast iron (girth gear).

Open Gears – where the mighty forces rule lubricants play a crucial role

Open Gears transmit extreme forces. Their service life is subject to several factors, one of them being the lubricants used. FUCHS LUBRITECH offers the ideal lubricant range for this heavy-duty application. Our Multi-Phase-Lubrication is the key to the efficiency and long life of your Open Gear.

The lubricant plays an important role

The purpose of all design and tribotechnical efforts is to ensure, in spite of the enormous stresses, long-term, trouble-free operation. The primary cause of damaged gear wheels is not exclusively the problem of faulty adjustment of the drives and radial and axial run-out, but also the use of unsuitable lubricants, shortage of lubricant and its incorrect application. Therefore an optimum load-carrying capacity and smoothed gear teeth are to be achieved. An extremely precise alignment of the gears combined with the correct running-in procedures is essential. For the lubrication of Open Gears adhesive sprayable lubricants are most suitable.

The best solution has a name: CEPLATTYN

Wherever lubrication is required on highly stressed or pre-damaged gear drives, under arctic conditions or in high-temperature environments, FUCHS LUBRITECH offers the right lubricant from the CEPLATTYN product range. CEPLATTYN adhesive lubricants are recommended by all leading manufacturers of gears and machines.

Lubrication with the FUCHS LUBRITECH CEPLATTYN range of products fully meets the tough tribotechnical requirements. The CEPLATTYN range was developed in the early 60s as the first sprayable non-asphaltic adhesive lubricants. The brand name is a synonym for high-quality and reliable adhesive lubricants.

The CEPLATTYN range includes more than 20 different products and is approved by all major gear and machine manufacturers in the raw materials industry.

MULTI-PHASE-LUBRICATION

Three lubrication steps to ensure a long service life for the Open Gear

LUBRITECH MULTI-PHASE-LUBRICATION (M-P-L) is a sophisticated system for optimum lubrication and a long lifetime. Once the drive is precisely aligned, the selection of the correct lubricant is the next step in achieving a long service life.

The most reliable method

LUBRITECH MULTI-PHASE-LUBRICATION (M-P-L) is the most reliable method of averting serious mistakes. The use of M-P-L is essential with new gears but it is also helpful after a repair of damaged gear tooth flanks or at any time when the pinion or girth gear is changed. LUBRITECH M-P-L consists primarily of three components: priming, running-in and operating lubricants. These special M-P-L lubricants are the result of many years of research, and have proved themselves in practical applications all over the world.

The best possible protection against wear

Optimum load transmission implies that the stress is evenly distributed across the full width and height of the teeth. However, for Open Gear drives in particular, even state-of-the-art manufacturing techniques and the most precise alignment possible hardly permit this optimum state to be achieved. The consequences of inadequate load distribution are excessive heating, scuffings, pitting and, in the worst case, even tooth breakage. The operator can, however, have a significant influence on such damage type, and thus on the lifetime of the drive, by selecting the right lubricant.

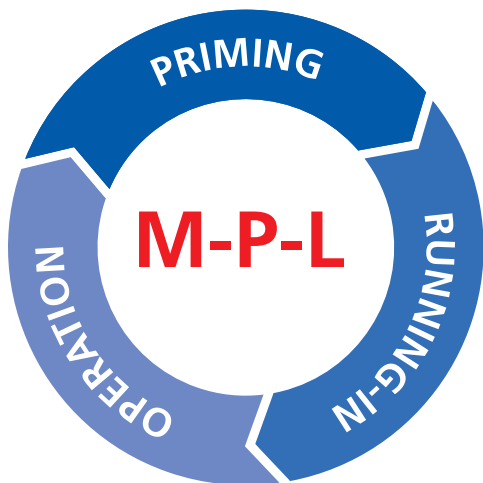

Priming

Priming lubricants prevent damage during initial operation and are manually applied to the clean teeth of a new or repaired gear. After the first rotations using an auxiliary drive the gear will display the actual contact pattern. Any corrections needed will be shown and can be implemented.

Running-in

Running-in is effected by our RN range of CEPLATTYN. Working tooth flanks are smoothed in this process, which is considered successful as soon as a load-carrying proportion of at least 80% has been achieved.

Operational lubrication

Operational lubrication starts at the end of the running-in process. It is not only subject to the condition and use of the drive but also to environmental influences.

Reference table: the right lubricant for each lubrication step

M-P-L	Lubricants	
Priming lubricants	CEPLATTYN 300 CEPLATTYN GT P CEPLATTYN SF P	Initial lubrications Manual applications
Running-in lubricants	CEPLATTYN RN CEPLATTYN GT RN CEPLATTYN SF RN	Surface smoothing Automatic spray systems
Operational lubricants	CEPLATTYN KG 10 HMF range CEPLATTYN GT range CEPLATTYN SF range	Regular lubrication Automatic spray systems

LUBRITECH M-P-L can only be applied to a limited extent to drives that are not lubricated by an automatic spray system. FUCHS LUBRITECH Service Engineers will be pleased to advise you on the running-in of gears, the operating lubrication of which is subsequently performed manually by dipping or circulation lubrication.

The best solution has a name: CEPLATTYN

On page 29 of this brochure you will find the complete product selection guide, which shows the available lubricants for the different fields of applications.

Priming

Priming is the first process step of Multi-Phase-Lubrication. Priming the tooth flanks is necessary to provide initial lubrication during the first revolution of the gears, in the course of assembly.

Priming lubricants prevent damage

Due to the surface finish of the gear teeth, priming is crucial to prevent damage during initial operation. In the context of FUCHS LUBRITECH Multi-Phase-Lubrication (M-P-L) priming or initial lubrication is effected with CEPLATTYN 300 / CEPLATTYN GT P / CEPLATTYN SF P immediately after the assembly of the drive.

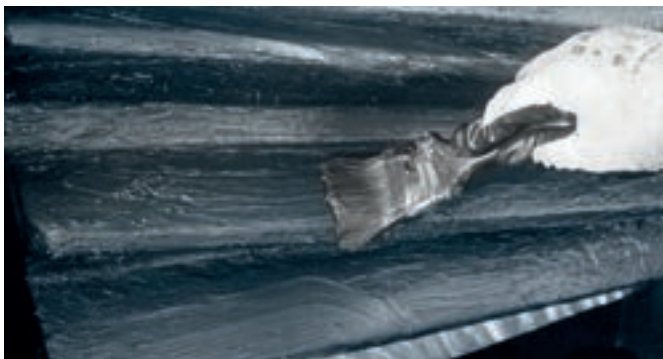

A layer of lubricant must be applied evenly and without air bubbles.

Priming and checking the contact pattern

It is necessary to fully clean the tooth flanks before applying a lubricant for the first time. The whole tooth flank area should be thoroughly cleaned up to the bare metal. The tooth flanks are then primed with CEPLATTYN 300 / CEPLATTYN GT P / CEPLATTYN SF P using a stiff-bristled brush or a spatula. Its application includes the working flanks, tooth roots, back flanks and tips in order to avoid corrosion and damage due to any movement during assembly. After priming, turning the gears with the auxiliary drive will result in the actual contact pattern being projected onto the working tooth flanks. Any areas devoid of lubricant must be primed again. The projection facilitates any correction of the transmission gear that may be required.

CEPLATTYN 300 / CEPLATTYN GT P / CEPLATTYN SF P cannot be applied with automatic spray systems.

Quantity of CEPLATTYN 300 / CEPLATTYN GT P / CEPLATTYN SF P

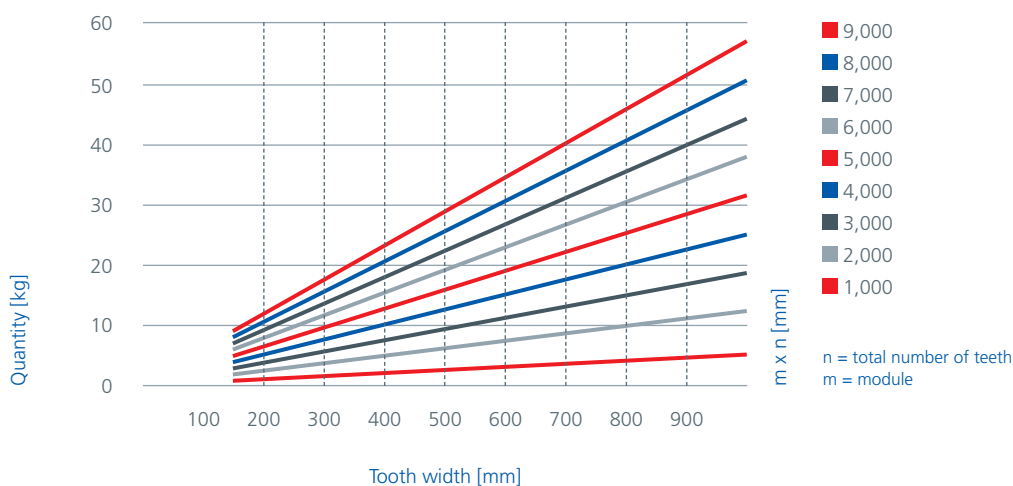

Various contact patterns and their causes

360° picture girth gear

girth gear pinion

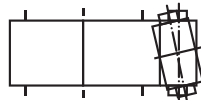

Contact pattern at the perimeter of the girth gear when the pinion wobbles. ▶ Check seating of pinion.

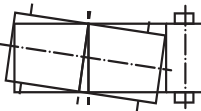

Contact pattern for wobble impact of the girth gear. ▶ Check alignment and fixing of the girth gear.

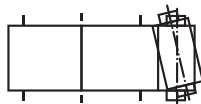
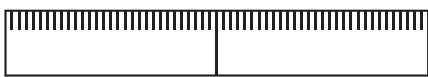

Contact pattern due to edge loading. Axles not sufficiently parallel. ▶ Realign pinion.

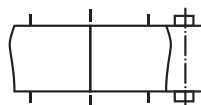

Circulating pressure point, resulting from manufacturing fault or isolated thermal deformation (protuberances).

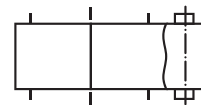
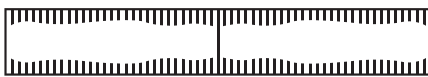

Contact pattern from pinion expanded on both sides, resulting from incorrectly assembled ring tensioning elements.

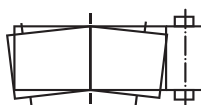

Contact pattern with opposing obliquity of the two halves of the girth gear. ▶ Check the impact point bolting.

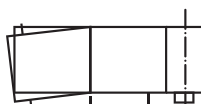

Contact pattern when one half of the gear is oblique. ▶ Check assembly.



Radial run-out of the gear wheel. The contact pattern appears weaker or stronger over half the perimeter of the girth gear. ▶ Readjust.

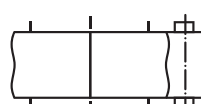

Contact pattern when the girth gear has protuberances on both sides, resulting from excessive frictional heating of the jacket seals (often found in oil-lubricated drives). ▶ Improve lubrication of seals. Check assembly of seals.

Running-in

Running-in is the second process step of Multi-Phase-Lubrication or after Re-Conditioning. The following case study offers a detailed overview of this process step.

Case study:

Better load-carrying pattern after Re-Conditioning

Even after the drive has been correctly aligned, the initial load-carrying proportion often remains below 50–60 %. The reason for this is the surface roughness arising in the course of manufacture on the one hand and deviations of the flanks due to their shape and due to assembly on the other hand. This means that there is a very high risk that drives can be damaged at this early stage of initial operation as a result of local overload. Such damage can be slight local scuffing or cracks that propagate in the form of pitting caused by fatigue damage during subsequent operation.

Axial run-out deviations caused the contact pattern of a cement mill drive to be only 40% in some areas. Since it was not possible to achieve an improved contact pattern through alignment, the drive had to be submitted to a forced running-in using RE-CONDITIONER. The load peaks that are obvious in the part marked red of the working tooth flanks (left-hand picture) were eliminated by Re-Conditioning (right-hand picture). The pitch line covers the full width of the tooth (visible in the picture as a white line on the working tooth flank).

CEPLATTYN RN/CEPLATTYN GT RN/CEPLATTYN SF RN removes the manufacturing roughness and it smoothes the working tooth flanks.

The economical way to a higher gearing quality

Controlled running-in with CEPLATTYN RN/CEPLATTYN GT RN/CEPLATTYN SF RN running-in lubricants prevents damage in the course of initial operation. CEPLATTYN RN/CEPLATTYN GT RN/CEPLATTYN SF RN eliminates manufacturing roughness and smoothes the load-carrying surfaces of tooth flanks, thus overcoming slight deviations

in shape and assembly and significantly increasing the contact area. The result: significantly enhanced gearing quality that provides the basis for a long service life.

The running-in procedure

The time required for running-in can only be assessed individually and is subject to the hardness of materials, manufacturing tolerances and the way in which a gear has been assembled. On average, the time required to efficiently run in drives on ball mills and kilns in single load steps is 350 hours, during which the lubricant should be continuously applied to the extent possible.

Values may vary in practical applications. The process must be adapted to the given operating conditions. The state of the tooth flanks should be checked throughout the running-in process. This particularly applies to the change of grinding charge, which should only be undertaken when the load-carrying proportion given in the table has been reached. If the contact pattern is considerably worse, readjustment of the transmission gear will be required. Running-in can be considered complete as soon as, at maximum charge or throughput, a load-carrying proportion of at least 80 % has been achieved, and the manufacturing roughness of the loaded teeth surface has been smoothed.

In cases where normal running-in does not result in a sufficient contact pattern or the drive has to be run in at full load, a forced running-in (the quick running-in method) represents the best solution. This forced running-in procedure is also suitable for achieving an optimum carrying capacity and surface finish if the load-carrying surfaces show scuffings, or under unfavourable circumstances if old and new gears have been combined.

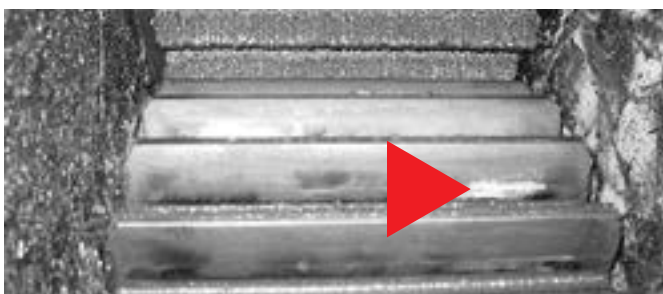

Before running-in

Due to assembly and misalignments load peaks often occur when starting a new drive.



Even load contact

After a selective running-in using CEPLATTYN RN/CEPLATTYN GT RN/CEPLATTYN SF RN these load peaks are eliminated and a good contact pattern across the flank width is achieved.

Surface roughness profiles of tooth flanks

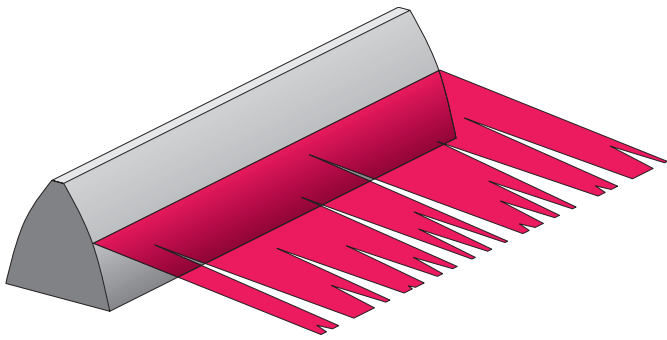

Load-carrying pattern before running-in approx. 50%

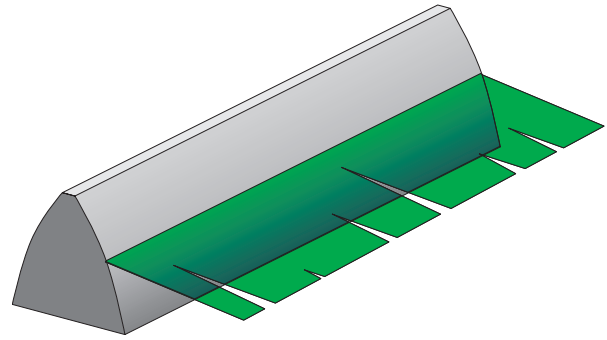

Load-carrying pattern after running-in approx. 85%

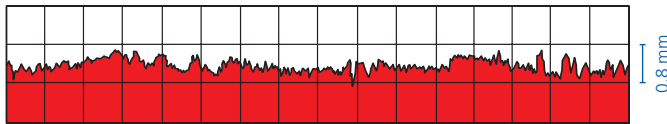

Before running-in with
CEPLATTYN RN
CEPLATTYN GT RN
CEPLATTYN SF RN

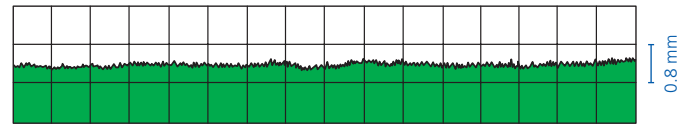

After running-in with
CEPLATTYN RN
CEPLATTYN GT RN
CEPLATTYN SF RN

Quantity of CEPLATTYN RN / CEPLATTYN GT RN / CEPLATTYN SF RN

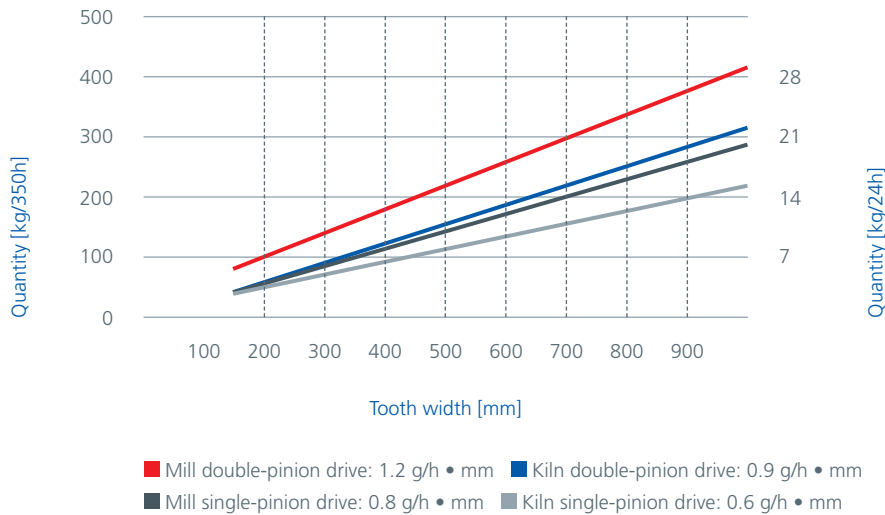

Operational lubrication

Operational lubrication is the third process step of Mult-Phase-Lubrication. The selection of the right lubricant in the process step plays an important role in the overall lifetime of the gear set.

Central lubricant supply with CEPLATTYN

Once priming and running-in have been successfully completed, the next point to be considered is operational lubrication. Making the right selection here is very important in terms of low wear, operation without damage, and lifetime of the Open Gear drive. The selection of the lubricant depends on a large number of factors including stress on the working tooth flanks, rotary speed of the transmission gear, actual flank temperatures and condition of the drive. Environmental influences such as dust contamination, humidity and very low or very high ambient temperatures must also be considered.

On the safe side with CEPLATTYN

The changeover to operating lubrication starts at the end of running-in. When changing to the operating lubricant a cleaning procedure is not required. It is just the drum container attached to the lubrication system that has to be replaced. CEPLATTYN lubricants are adhesive lubricants which are suitable for extremely high pressures. They are resistant to water and approved by all leading gear and machine manufacturers.

Changeover to operational lubrication

In practice the changeover is achieved through a gradual quantity reduction to a targeted minimum (see graph on the right). It is necessary to measure the quantity every time this value is reduced by the spray system. Small volumes frequently applied avoid phases in which the drive is excessively saturated with lubricant, thus preventing fling-off. The short breaks between cycles prevent a lack of lubrication. Quantity guidelines for various drives are included in the diagram on the right.

Quantity reduction

e.g. for a single-pinion drive

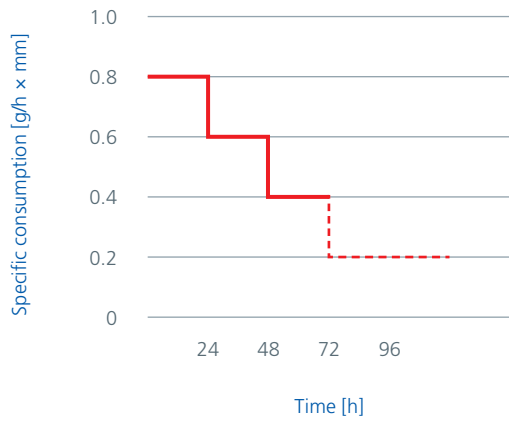

Note: The attainable minimum quantity is directly subject to the operating conditions. Lubrication rates below the minimum may create an increased risk of wear and damage on the tooth flanks.

Quantity of CEPLATTYN for operational lubrication

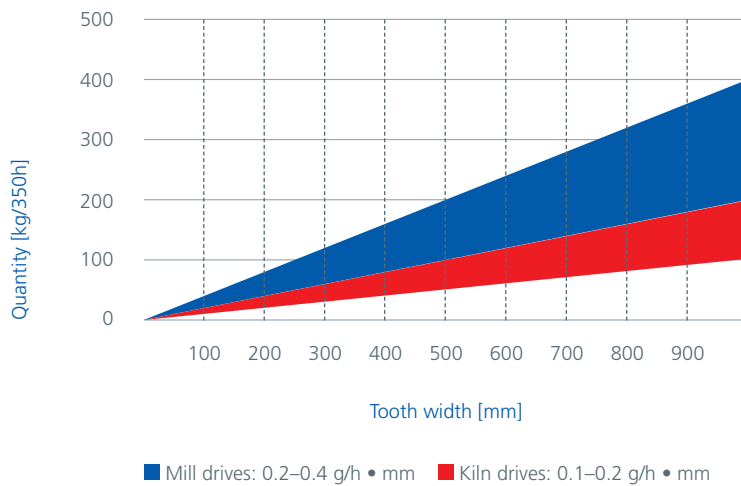

Note: For double-pinion drives, please calculate at a factor of 1.5.

TAILOR-MADE SERVICE AND MAINTENANCE

Our local experts contribute through their broad process-spanning expertise and on-site technical consultation to the performance, efficiency and process reliability of your entire application. Whether you want specialist advice with a view to reducing your number of lubricants, longer lubrication intervals or the perfect Open Gear services, we provide you with precisely the support you need to further optimise your use of lubricants.

FUCHS LUBRITECH Open Gear inspection procedure

- Visual check of Open Gear and surrounding conditions
- Pinion and girth gear check
- Vibrations on the pinion bearings
- Temperature conditions on the pinion bearings
- Temperature conditions on the mill/kiln shell
- Check of the spray system
- Inspection of spray and pump equipment
- Temperature conditions across the tooth surfaces of the pinion and girth gears
- Quantity determination of the lubricant
- Documentation of the result in the FLT INSPECTOR online system

Running-in of new gears

Specially trained service engineers assist with the commissioning and running-in of new gears. They ensure that the drive is run-in optimally according to the principle of the LUBRITECH MULTI-PHASE LUBRICATION (M-P L) with accurately defined application quantities of the appropriate CEPLATTYN lubricant.

Service – inspection and repair

Regular inspection of Open Gears

For drive units that are lubricated with CEPLATTYN, our service engineers carry out regular inspections over the entire service life. They make written notes of the general operational status, ascertain the amount of wear on the load-carrying tooth flanks, check the spray lubrication and,

if necessary, reset it. In addition, the service engineer takes extensive measurements (oscillation speed, flank temperature, etc.), which are recorded in the FLT INSPECTOR, a modern documentation system, and are always available to our customers.

Measuring vibrations of the pinion bearing



Measuring the tooth flank temperature



Dynamic check of the contact pattern with a stroboscope



Dynamic check by infrared video thermography



Repair service

The repair of damaged tooth flanks on Open Gear drives is part of the extended service offered by FUCHS LUBRITECH. Such repair work is primarily a matter of the mechanical treatment of the working tooth flanks by grinding pittings or larger breakages, smoothing scuffings, forced

running-in and assistance with alignment of the transmission gears. On heavily worn-out or damaged tooth flanks FUCHS LUBRITECH can provide complete reprofiling of the entire gear set.

Tooth flanks before grinding



During grinding process



Tooth flanks after grinding

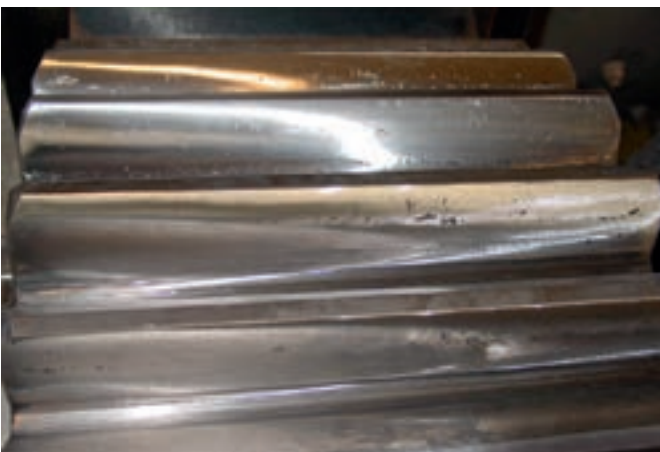

Older pitting and reworked pitting

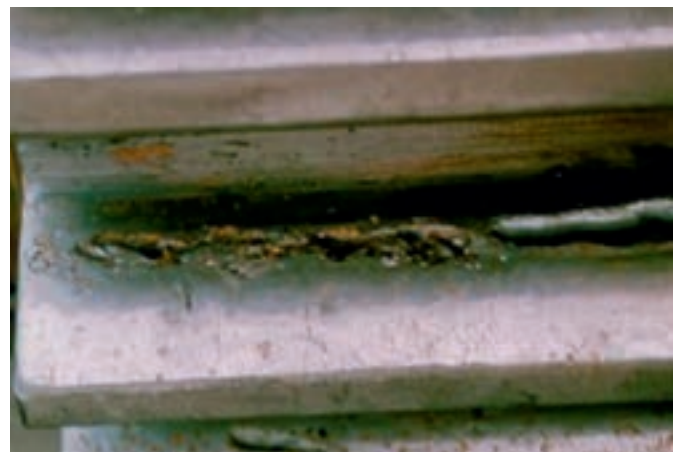

Tooth flank damage and its causes in Open Gears

Gears in a wide variety of designs provide movement throughout the industry. If a gear wheel suddenly stops, the causes can differ considerably. Statistically speaking, damaged tooth flanks account for about 60 per cent of gear drive defects.

The correct lubricant eliminates many damage causes. It does not matter whether a light oil or an adhesive lubricant is under consideration. Nor does it matter whether it is a high-speed vehicle gearing or a low-speed Open Gear drive: whenever teeth mesh the appropriate lubricant is one of the most important factors for smooth operation. Scuffings and abrasive wear, for example, can

be influenced to a large extent by the lubricant. A poor-quality lubricant also has a direct adverse effect on the occurrence of fretting corrosion, scoring and scuffings. The consequences of a lack of lubricant usually include increased wear or deformations such as the development of rippling and hot or cold flow. The chart below gives a basic overview of the problems that can be experienced.

Cracks



Pittings/seizure



Deformations

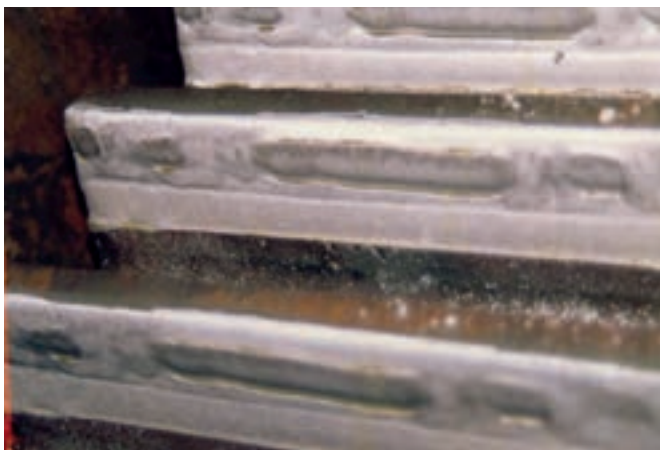

Tooth breakages



The causes of tooth flank damage in Open Gears

	Cracks			Pittings			Deformations			Tooth breakage			Wear			Corrosion			Other types of damage					
	Grinding cracks	Hardness cracks	Material cracks	Fatigue cracks	Initial/destructive/fatigue pitting	Flaking	Spalling	Indentations	Rippling	Hot flow	Cold flow	Overload breakage	Fatigue breakage	Normal wear	Abrasive wear	Interference wear	Scratches	Scoring	Scuffings	Chemical corrosion	Fretting corrosion	Cavitation	Erosion	Overheating
	Cracks			Pittings			Deformations			Tooth breakage			Wear			Corrosion			Other types of damage					
Operational conditions/assembly faults	Alignment errors			■	■	■					■	■	■											
	Fixing of pinion			■	■	■					■													
	Frequent load changes				■								■											
	Overload			■	■		■	■			■	■						■	■					■
	Impact/vibration stress	■			■		■	■			■	■									■	■		
	Incorrect running-in				■															■				
	Speeds too low/high				■						■								■	■				
	Dust ingress							■							■	■		■	■	■				■
	Dynamic changes				■	■		■	■		■		■											■
	Shortage of lubricant				■				■	■	■				■									
Lubrication faults	Wrong consistency			■				■						■				■			■			
	Inadequate quality			■				■						■				■			■			
	Soiling with solids/liquids							■						■		■	■		■		■	■		
	Incorrect application								■					■					■					

Re-conditioning service

Forced running-in with RE-CONDITIONER

In cases where normal running-in does not result in a sufficient contact pattern or the drive has to be run in at full load, a forced running-in (the quick running-in method) represents the best solution. This forced running-in procedure is also suitable for achieving an optimum load-carrying capacity and surface finish if the load-carrying surfaces show scuffings. In case a new pinion is installed in combination with an old girth gear

Re-Conditioning is used to reprofile the old girth gear with the new profile of the pinion. Forced running-in involves a service lubricant known as RE-CONDITIONER being manually applied to the working surfaces in addition to the regular CEPLATTYN RN lubricant during production. This RE-CONDITIONER effects a smoothing of the working surfaces within in a shorter time, thus tremendously reducing the running-in time.

The use of RE-CONDITIONER

Before

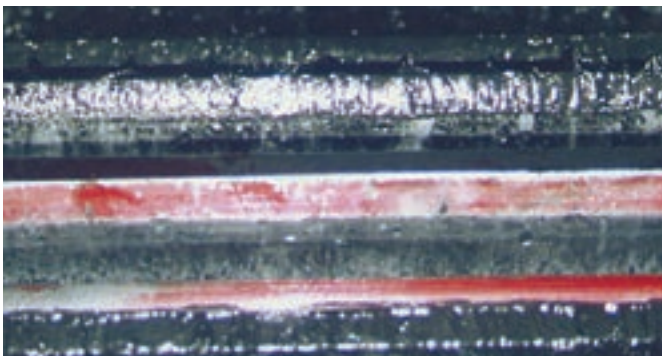

red = no contact

After

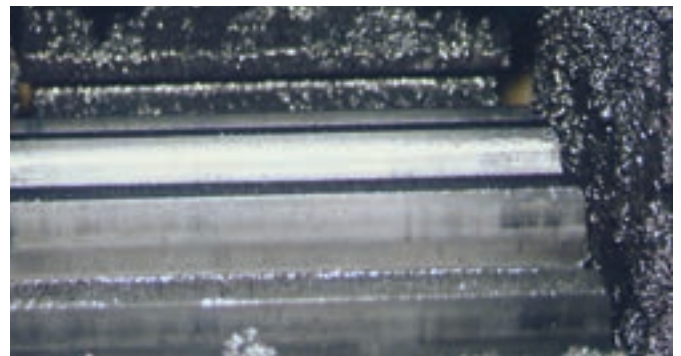

complete tooth contact

Case study: smoother running after Re-Conditioning

When restarting a helical, double-pinion cement mill small deviations in axial and radial run-out of the girth gear had the effect of high vibration differences between the pinion bearings. At the run-out pinion the vibration levels were well below 2 mm/s, but they were above 8 mm/s at the run-in pinion. The operator could not accept this large difference. Even after several corrections of the trans-

mission gear no improvement was achieved. The manufacturer of the machinery therefore initiated a forced running-in. The application of RE-CONDITIONER for nine hours resulted in a carefully controlled redistribution of the load: the vibrations of both bearings were eventually below 2 mm/s. Result: a smooth operation.

The material removal generated through using the RE-CONDITIONER requires specialised technical knowledge. Forced running-in is only carried out by FUCHS LUBRITECH Service Engineers. For gears under warranty the machine or gear manufacturer must agree to this procedure being conducted prior to the start of the procedure.

Vibration monitoring

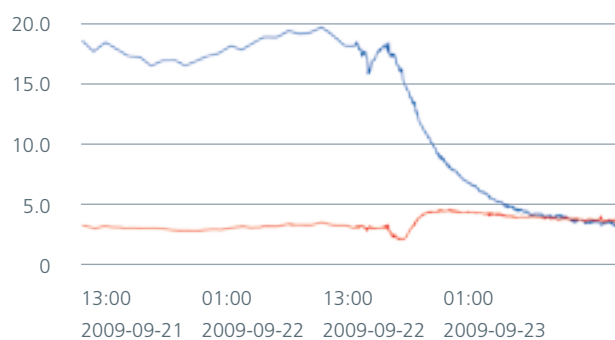

■ run-in pinion ■ run-out pinion

Extract from permanent vibration monitoring at the plant.
Reduction of vibrations during forced running-in.

FLT INSPECTOR – online documentation

With the FLT INSPECTOR, FUCHS LUBRITECH is making a unique online documentation database with an integrated, graphical trend analysis available that enables the customer to retrieve all relevant information on their system and the lubricants used at any time.



The open gear service, combined with the online provision of inspection reports, is a further step towards being able to operate open running drives reliably.

Your benefits with the FLT INSPECTOR

- Availability of all reports at a glance
- Online access at any time
- Instant check via a traffic light system
- Graphical trend analysis for temperatures and vibrations
- Rapid transmission of data and reports
- Individual access hierarchy
- Optional extra information (attachments) for each inspection report
- App solution for mobile devices

Sample report from our FLT Inspector

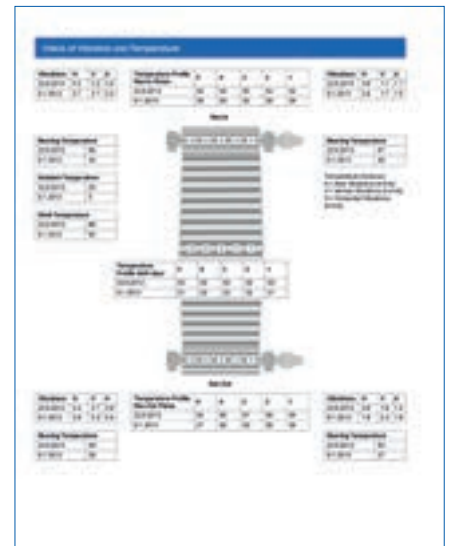

First part of the inspection report contains customer and system data, as well as images and comments.

Measurements of values for temperatures and vibrations, including reference values relating to the previous inspection, can be found in this second part.

Tooth flank temperature run-in pinion

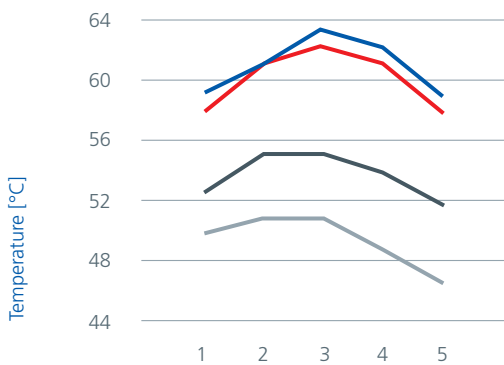

Checkpoints across the tooth width [mm]

■ 18 Feb. 2015 ■ 11 May 2015
 ■ 23 Mar. 2016 ■ 26 Jul. 2016

Graphic trend analysis enables informative display of temperatures and vibrations over time.

Vibration run-out of pinion/fixed end

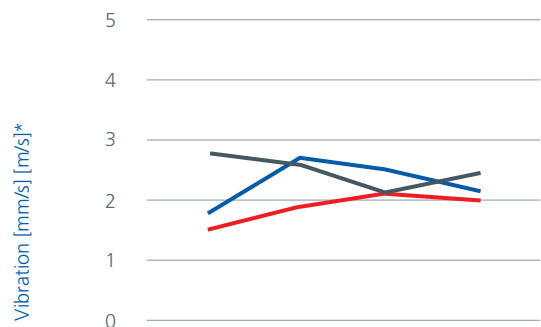

18 Feb. 2015 11 May 2015 23 Mar. 2016 26 Jul. 2016

■ Horizontal ■ Vertical ■ Axial

Guide values for adjustment and assembly

The commissioning engineer of Open Gear drives is faced with extremely tough requirements when aligning or correcting the drive. Careful alignment of girth and transmission gears is of critical importance for the service

life of the drive. This is why it is usual for assembly companies to prepare records of measurements of radial and axial run-outs, backlash and root clearance.

Maximum concentric and axial run-out deviation of Open Gears as a function of girth gear diameter

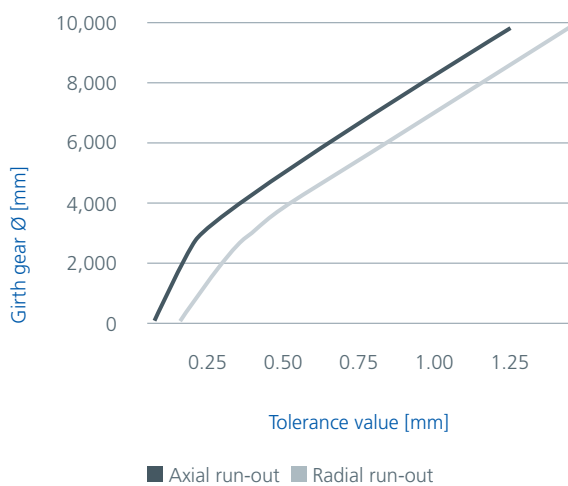

Adjustment of the tooth flank clearance for mills and rotary kilns

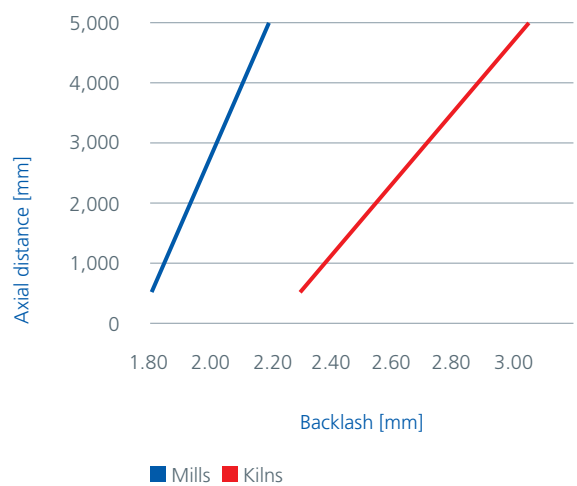

If a gear set must be reversed because of wear, it will no longer be possible to align the gears by means of the backlash. The drive must be set up using the tip clearance. A suitable guide value for the tooth tip clearance is 0.25 to 0.3 times the module.

Inspecting the spray system

The following points should be observed before commencing operation of the machinery:

- Functional test
- Spray pattern and overlap
- Spray angle
- Nozzle distance
- Lubricant quantity

The increased throughput of a running-in lubricant is necessary in order to flush out any metallic particles due to the removal of the rough surface peaks. The lubricant must then flow freely and drain away to prevent blockages and build-up of any waste.

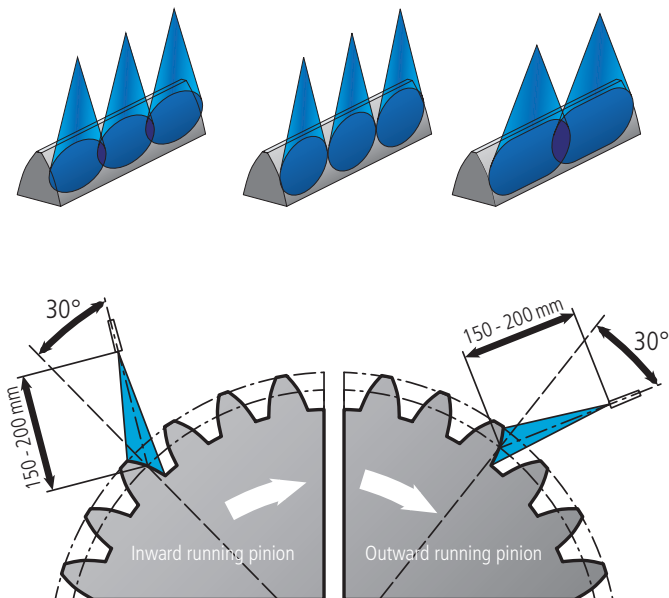

Complete solutions: the CEPLATTYN® ranges

FUCHS LUBRITECH offers three different CEPLATTYN ranges, thus always providing our customers with the ideal lubricant for mill or kiln gears.



CEPLATTYN KG 10 HMF range

The lubricants of the CEPLATTYN KG 10 HMF range include black, graphite-containing greases suitable for any kind of Open Gear. The CEPLATTYN KG 10 HMF range provides excellent wear and damage protection for mill and kiln gears. Suitable grades for spray, bath and circulation application are available.

CEPLATTYN GT range

The CEPLATTYN GT range includes milk-coloured, white solid lubricant-containing, high viscosity-fluids suitable for all kinds of Open Gears. Like the graphite-containing greases they provide optimum wear and damage protection for mill gears and low-speed kiln gears. They contain flame-retardant additives to prevent fire on kilns, build up a suitable sealing layer to avoid the occurrence of oil leakages and are well pumpable. The CEPLATTYN GT range comprises suitable viscosities for spray, bath and circulation applications and can be used on AGMA and DIN/ISO-designed gears.

CEPLATTYN SF range

The CEPLATTYN SF range includes light-coloured, high-viscosity fluids without solid lubricants. They are designed for use in any kind of mill gear and are especially suitable for use on AGMA-designed gears for high-powered mills in the mining industry. The lubricants of the CEPLATTYN SF range are mainly intended for spray application.

Open Gear CEPLATTYN® products and application

Product	Description	Field of application	Method of application
CEPLATTYN® 300	Paste with a high graphite content, high-pressure additives	As primer for large Open Gears, gear racks and sliding surfaces	Manually to clean surfaces; do not use in centralised lubrication systems!
CEPLATTYN® RN	Sprayable running-in lubricants for Open Gears	Can be applied to single- and double-pinion drives of any kind of tube mills and kilns	Via automatic spraying systems. Spraying should be effected permanently and highest possible quality
CEPLATTYN® KG 10 HMF	Sprayable running-in lubricants for large Open Gears	Is used on Open Gear drives of tube mills and kilns, dryers and crushers	Applied via standard spray lubrication systems
CEPLATTYN® KG 10 HMF-1000	Sprayable, graphite-containing adhesive lubricant for Open Gears	Is used for heavy-load applications because of its high base oil viscosity	Applied via standard spraying system
CEPLATTYN® KG 10 HMF-2500	Highly viscous, sprayable adhesive lubricant for Open Gear drives	Suited for shock loads in heavy-duty applications because of its high base oil viscosity and the resulting good cushioning effect	Sparingly applied by commercially available spraying systems
CEPLATTYN® KG 10 HMF LC	Sprayable, extremely high-viscosity adhesive lubricant for Open Gears	High base oil viscosity and thus good damping characteristics make it especially suitable for shock-loaded gear in heavy-duty applications	Applied economically via conventional spray lubrication systems. At temperatures below +5°C/+40°F additional heating systems may have to be used for spraying
CEPLATTYN® GT P	Priming lubricant with white solid lubricants	Is used as priming lubricant for Open Gears	By spatula, brush or non-fibre cloth onto previously cleaned surfaces. Not suitable for spray lubrication systems
CEPLATTYN® GT RN	Sprayable running-in lubricant for Open Gears	Is used to smoothen the tooth surface of newly installed gear rims or pinions and for optimisation of the load-carrying pattern	Via automatic spraying systems. The lubricant quantity should be 2–3 times higher compared to operational lubricant quantities
CEPLATTYN® GT 10	Light-coloured, high-viscosity adhesive lubricant with white solid lubricants for Open Gears	Especially for Open Gears under critical operating conditions, such as slow-speed kiln drives with increased tooth flank temperatures, mill drives with extreme drive power, and drives which are frequently operated under start-stop conditions	Suitable for application in immersion baths, circulation lubrication and spraying systems
CEPLATTYN® GT 3	Light-coloured, high-viscosity adhesive lubricant with white solid lubricants for Open Gears	Especially for application on Open Gears under critical operating conditions	Suitable for the application in immersion bath and circulation lubrication systems
CEPLATTYN® SF P	Priming lubricant for Open Gears with white solid lubricants	Used as priming lubricant for Open Gears	By spatula, brush or non-fibre cloth onto previously cleaned surfaces; caution: not suitable for spray lubrication systems!
CEPLATTYN® SF RN	Sprayable running-in lubricant for Open Gears	Is used to smoothen the tooth surface on newly installed gear rims or pinions and for optimisation of the load-carrying pattern	Via automatic spraying systems. The lubricant quantity should be 2–3 times higher compared to operational lubricant quantities
CEPLATTYN® SF 10	Light-coloured, highly viscous adhesive lubricant for Open Gears on mills	Especially for heavy-duty, high-speed open mill drives subject to high vibrations	Via commercially available spraying systems
CEPLATTYN® SF 30	Sprayable, extremely high-viscosity lubricant for Open Gears	Especially for extremely heavy-duty Open Gear drives exposed to high shock loads	Via spray systems





Innovative lubricants need Experienced application engineers

Every lubricant change should be preceded by expert consultation on the application in question. Only then the best lubricant system can be selected. Experienced LUBRITECH engineers will be glad to advise on products for the application in question and also on our full range of lubricants.



Contact:



Global Headquarters
FUCHS LUBRITECH GmbH
Werner-Heisenberg-Strasse 1
67661 Kaiserslautern/Germany
Tel.: +49 (0) 6301 3206-0
info@fuchs-lubritech.de
www.fuchs.com/lubritech

The information contained in this product information is based on the experience and know-how of FUCHS LUBRITECH GmbH in the development and manufacturing of lubricants and represents the current state-of-the-art. The performance of our products can be influenced by a series of factors, especially the specific use, the method of application, the operational environment, component pre-treatment, possible external contamination, etc. For this reason, universally-valid statements about the function of our products are not possible. Our products must not be used in aircrafts/spacecrafts or their components, unless such products are removed before the components are assembled into the aircraft/spacecraft. The information given in this product information represents general, non-binding guidelines. No warranty expressed or implied is given concerning the properties of the product or its suitability for any given application. We therefore recommend that you consult a FUCHS LUBRITECH GmbH application engineer to discuss application conditions and the performance criteria of the products before the product is used. It is the responsibility of the user to test the functional suitability of the product and to use it with the corresponding care. Our products undergo continuous improvement. We therefore retain the right to change our product program, the products, and their manufacturing processes as well as all details of our product information sheets at any time and without warning, unless otherwise provided in customer-specific agreements. With the publication of this product information, all previous editions cease to be valid. Any form of reproduction requires express prior written permission from FUCHS LUBRITECH GmbH.